

NOTES:

1. ALL DIMENSIONS FOR REFERENCE ONLY
2. REFER TO AIR LOGIC'S #10-32 INTERFACE & SEAL GUIDE
3. REFER TO AIR LOGIC'S POLYSULFONE APPLICATIONS GUIDE
4. TUBE RETENTION PRESSURE SUBJECT TO TUBING DIMENSION AND STIFFNESS

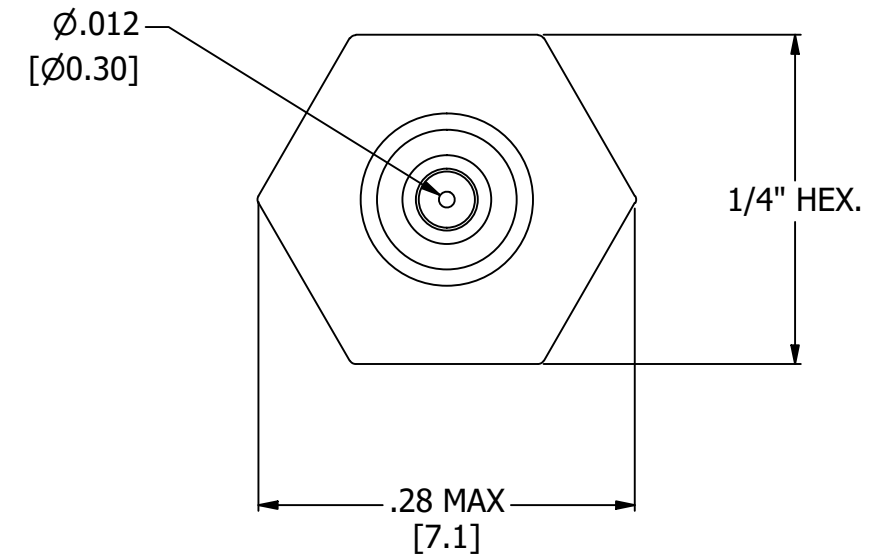
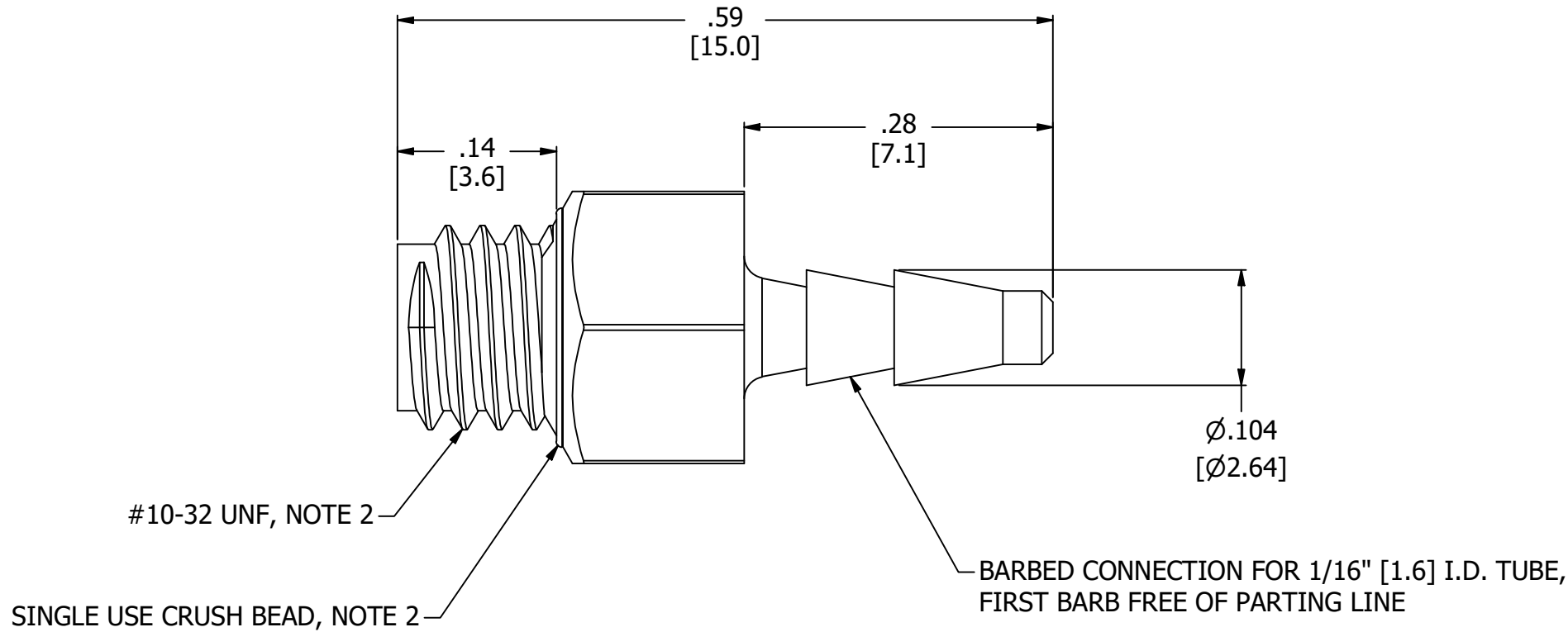
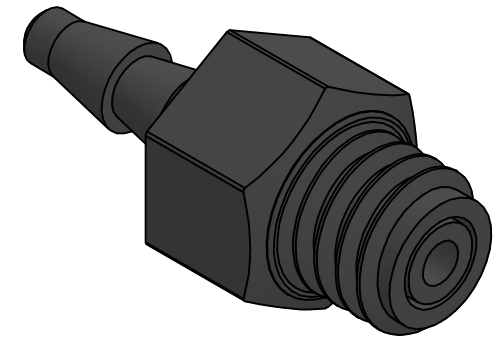

PRODUCT SPECIFICATIONS

COLOR(S)	BLACK
MEDIA	GASES, LIQUIDS, NOTE 3
MAX INLET PRESSURE	125 PSI, [8.6 BAR]
TYPICAL TUBE RETENTION PRESSURE	125 PSI, [8.6 BAR], NOTE 4
FLOW COEFFICIENT (Cv)	0.00372
NOMINAL ORIFICE DIAMETER	Ø.012 [Ø0.30]
WETTED MATERIALS	POLYSULFONE
RECOMMENDED SYSTEM FILTRATION	5 MICRON



**AIR-LOGIC** @ DIVISION OF KNAPP MFG, INC.  
 5102 DOUGLAS AVE RACINE, WI 53402  
 PHONE: (262) 639-9035 FAX: (262) 639-5996 WEB: AIR-LOGIC.COM

PART/DRAWING NO.:

**F3120121B80**

DESCRIPTION:  
 THREADED ORIFICE, Ø.012, #10-32 X 1/16" BARB

REVISION: A	DRAWN: 3/2/2021
SCALE: 7 : 1	SHEET SIZE: B

TERMS OF USE:  
 THIS DRAWING IS FOR INFORMATIONAL PURPOSES ONLY. AIR LOGIC MAKES NO REPRESENTATIONS OF WARRANTIES CONCERNING SUITABILITY FOR ANY PARTICULAR PURPOSE. ALL PRODUCTS SUPPLIED ARE SUBJECT TO TERMS AND CONDITIONS FOUND AT AIR-LOGIC.COM

DRAWING TAKES PRECEDENCE OVER 3D MODEL GEOMETRY  
 TOLERANCE: DECIMALS .00 ± .01, .000 ± .005, FRACTIONS ± 1/64  
 ANGLES 1/4° UNLESS OTHERWISE SPECIFIED  
 UNITS: INCHES [MILLIMETERS]